

# Owner's Manual

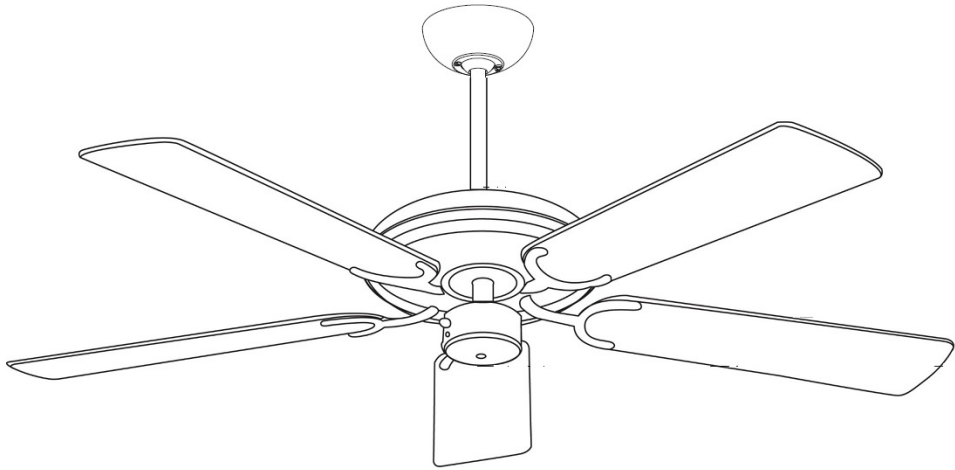

Model: **BALI**  
(Plywood Blades)



Model: **MINI FAN**  
(Plywood Blades)

**WARNING:** Read and follow these instructions carefully and be mindful of all warnings shown throughout.

## **READ AND SAVE THESE INSTRUCTIONS**







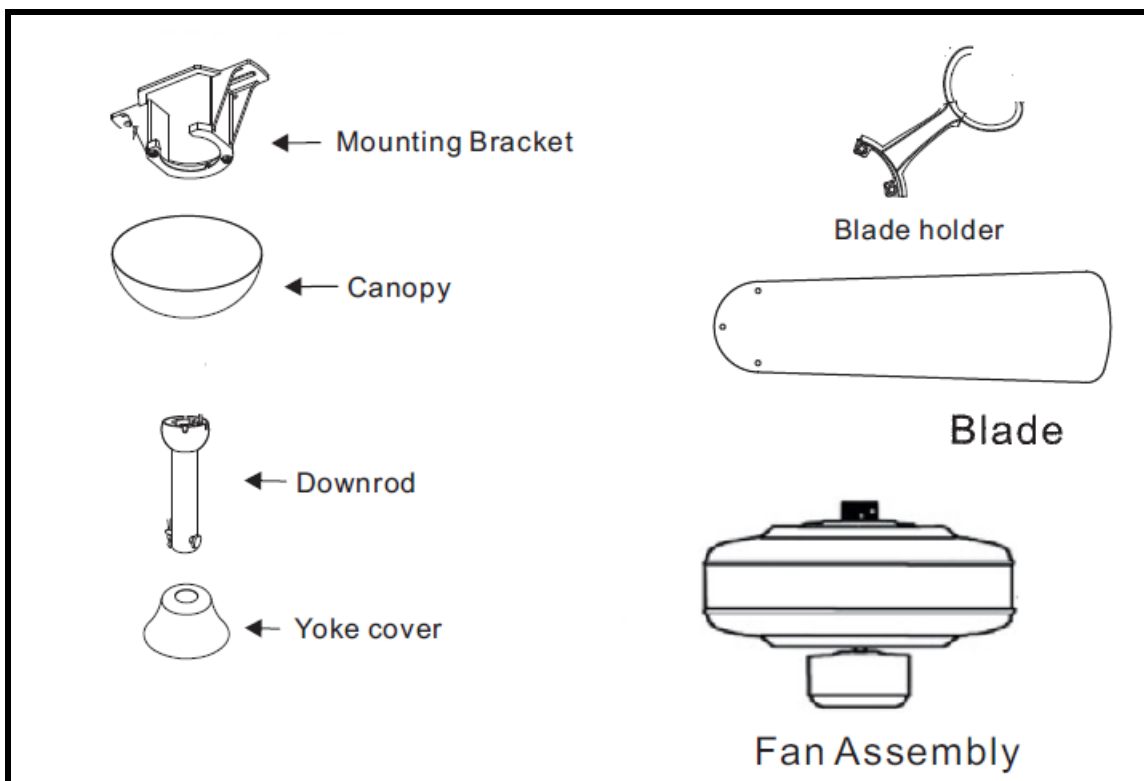



### **WARNING: TO REDUCE THE RISK OF FIRE, ELECTRICAL SHOCK, OR INJURY TO PERSONS, PLEASE OBSERVE THE FOLLOWING:**

- 1]. To ensure the success of the installation, be sure to read the instructions and review the diagrams thoroughly before beginning.
- 2]. To avoid possible electric shock, be sure electricity is turned off at the main power box before wiring.  
All electrical connections must be made in accordance with local codes, ordinances and/or the national electric code.  
If you are unfamiliar with the methods of installing electrical wiring and products, secure the services of a qualified and licensed electrician as well as someone who can check the strength of the supportive ceiling members and make the proper installations and connections.
- 3]. Make sure that your installation site will not allow rotating fan blades to come in contact with any object.  
Blades should be at least 2.3m from floor when fan is in operation.
- 4]. If possible, mount ceiling fan on a ceiling joist - the joist must be able to support the motion and weight of the moving fan.  
If the fan will be mounted on a ceiling outlet box, a 4" x 2-1/8" deep METAL octagon box is required; one UL listed as "suitable for fan support".  
The box and its supporting members must not be able to twist or work loose.  
**DO NOT USE PLASTIC BOXES.**  
Installation on a concrete ceiling should be performed by qualified personnel.
- 5]. Blades should be attached after motor housing is hung and in place.  
Fan motor housing should be kept in carton until ready to be installed to protect its finish.  
If you are installing more than one ceiling fan, make sure that you do not mix fan blade sets.
- 6]. After making electrical connections, spliced conductors should be turned upward and pushed carefully up into outlet box.  
The wires should be spread apart with the grounded conductor and the equipment - grounding conductor on one side of the outlet box and the "HOT" wires on the other side.
- 7]. Electrical diagrams are for reference only.  
Light kits that are not packed with the fan must be UL listed and should be installed per the light kit's installation instructions.
- 8]. After fan is completely installed, check to make sure that all connections are secure to prevent fan from falling and/or causing damage or injury.
- 9]. The fan can be made to work immediately after installation - the bearings are adequately charged with grease.  
So that, under normal conditions, further lubrication should not be necessary.
- 10]. The fan must be turned off and stopped before reversing fan direction.
- 11]. This fan is suitable for indoor location use.











**.Unpack and inspect fan carefully to be certain all contents are included.**



**Hardware bag for BALI Models**

|                    |        |   |
|--------------------|--------|---|
| Hanger             | 2 pcs  |  |
| Wood Screw         |        |  |
| Spring Washer      | 10 pcs |  |
| Motor Screw        | 10 pcs |  |
| Bracket Screw      | 2 pcs  |  |
| Screw Paper Washer | 15 pcs |  |
| Blade Holder Screw | 15 pcs |  |
| Pull Chain Knob    | 1 pc   |  |
| Wire nut           | 3 pcs  |  |
| Blade Balance Kit  | 1 pc   |  |

**Hardware bag for MINI FAN Models**

|                    |        |   |
|--------------------|--------|---|
| Hanger             | 2 pcs  |  |
| Wood Screw         |        |  |
| Spring Washer      | 8 pcs  |  |
| Motor Screw        | 8 pcs  |  |
| Bracket Screw      | 2 pcs  |  |
| Screw Paper Washer | 12 pcs |  |
| Blade Holder Screw | 12 pcs |  |
| Pull Chain Knob    | 1 pc   |  |
| Wire nut           | 3 pcs  |  |
| Blade Balance Kit  | 1 pc   |  |

# INSTALLATION INSTRUCTIONS

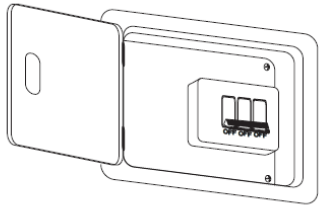

**2.**  
Turn off power at breaker box to avoid possible electrical shock.

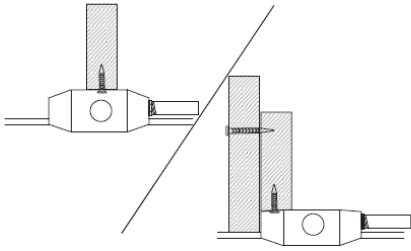

**3.**  
Use metal outlet box suitable for fan support. Secure outlet box directly to the building structure using wood screws (included). Outlet box must support 40 lbs min.

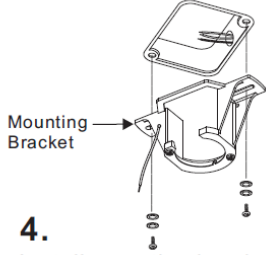

**4.**  
Install mounting bracket to Outlet box in ceiling using washers and the mounting screws provided with the outlet box.

**Do not use existing mounting bracket, replace it with new mounting bracket from box.**

## ★ Downrod & Yoke Installation ★

- ① Remove cross pin and cotter pin from downrod.
- ② Insert downrod through canopy and yoke cover, and feed motor lead wires through downrod.
- ③ Loosen 2 downrod jam screws at yoke. Insert downrod assembly into yoke.
- ④ Insert the cross pin through yoke & downrod and secure with cotter pin.
- ⑤ Tighten both downrod jam screws to further secure downrod.
- ⑥ Pull down the yoke cover to cover yoke.

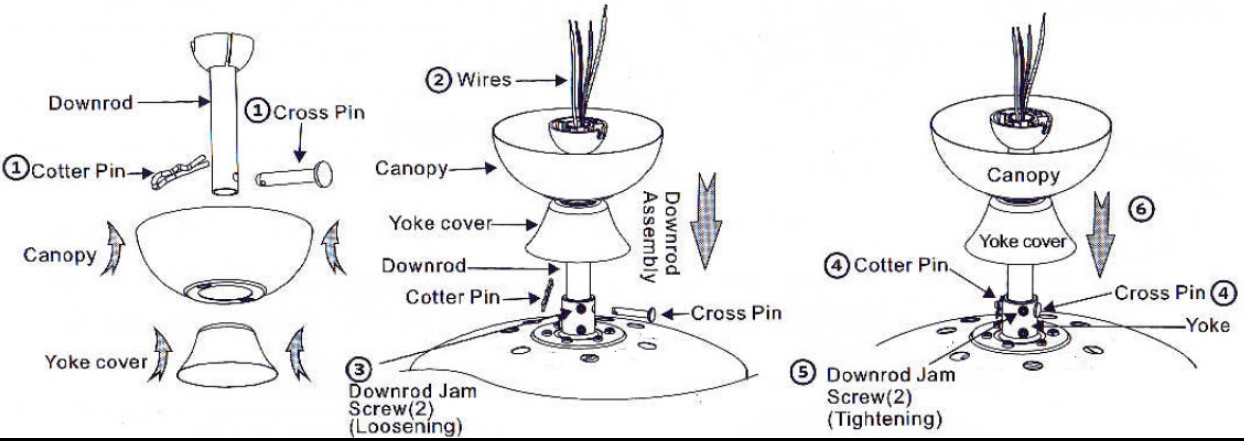

## ★ Motor & BLADE Installation ★

### Blades installation

Attach blade to blade holder with blade screw & rubber washer provided. Make sure that all screws are firmly tightened.

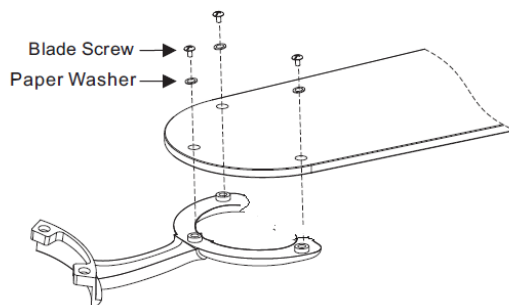

## Blades assembly to motor

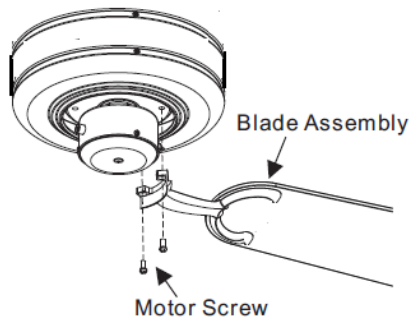

Mount blade assembly to motor housing by motor screws provided.

NOTE: Do not bend blade holder to prevent wobble.

## Hanging the fan

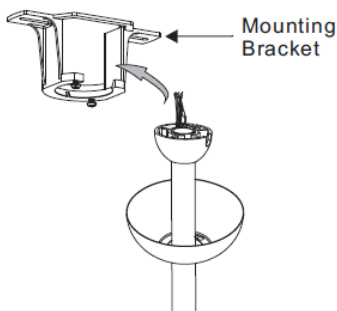

(1)  
Lift fan assembly onto mounting bracket.

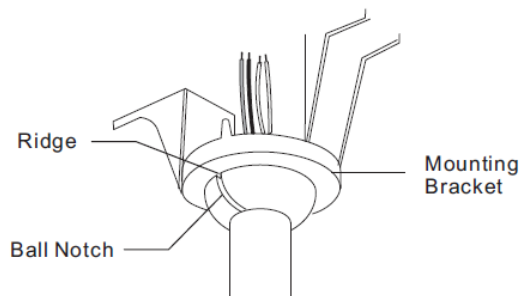

(2)  
Carefully lift fan assembly onto mounting bracket. Rotate fan so that the notch on the ball engages the ridge in the mounting bracket.

## Make wire connections for light kit if applicable

Insert wires existing from Light Kit Fitter by passing through center hole and attach Light Kit Fitter to Switch Housing Cover with threaded tube and /or fasten with spring washer and hex nut.

- (1). Blue wire from Light Kit to blue wire from fan and connect by wire nut.
- (2). Orange wire from Light Kit to orange wire from fan and connect by wire nut.

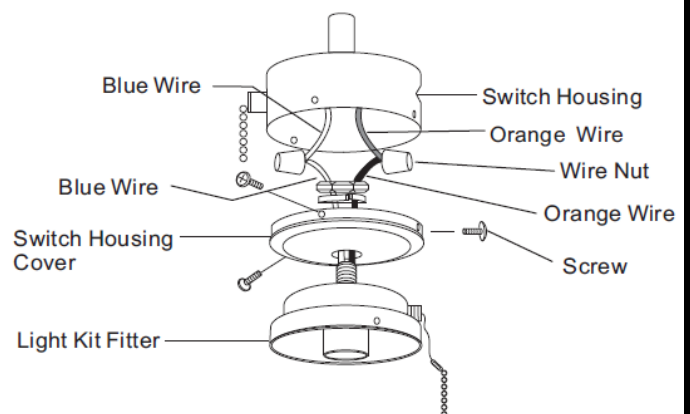

Attach switch housing cover and light kit assembly to switch housing by 3 original screws.

★★ Electronic Wiring Connection to be followed the installation guide depending on your option in wall controller/regulator or remote controller in below before you turn the power on.



# Electronic Wiring Connections

◇ For Wall Controller/Speed Regulator: (AC220~240V / 50Hz)

## Make wire connection

### Without Light

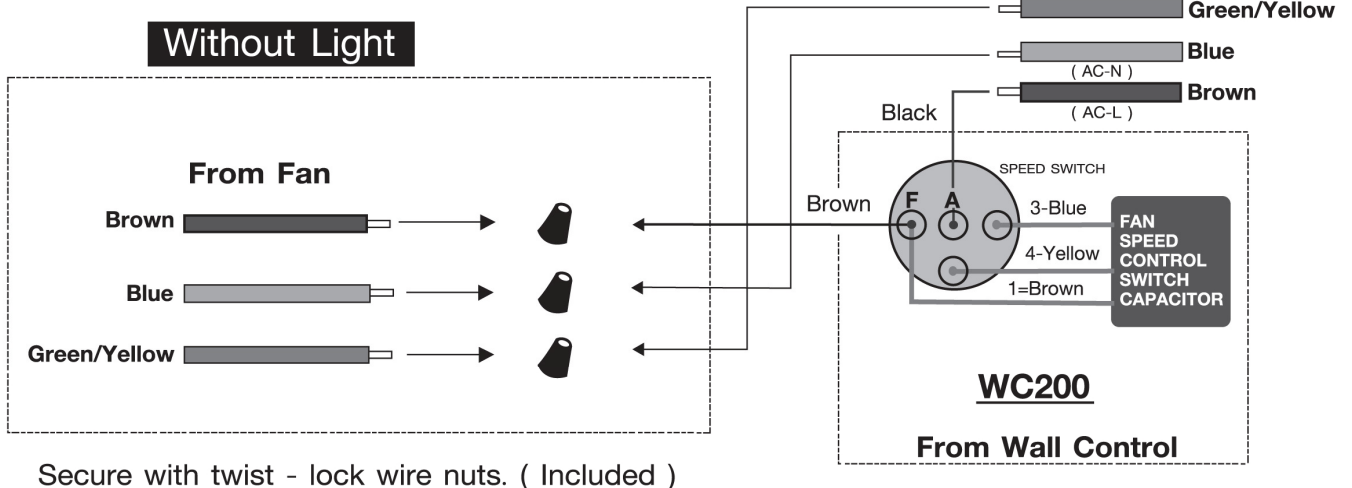

Secure with twist - lock wire nuts. ( Included )

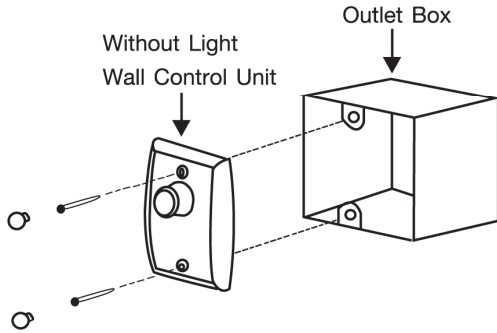

### With Light

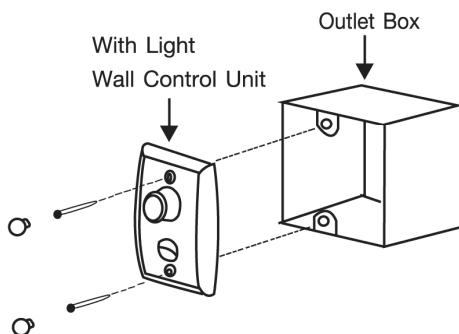
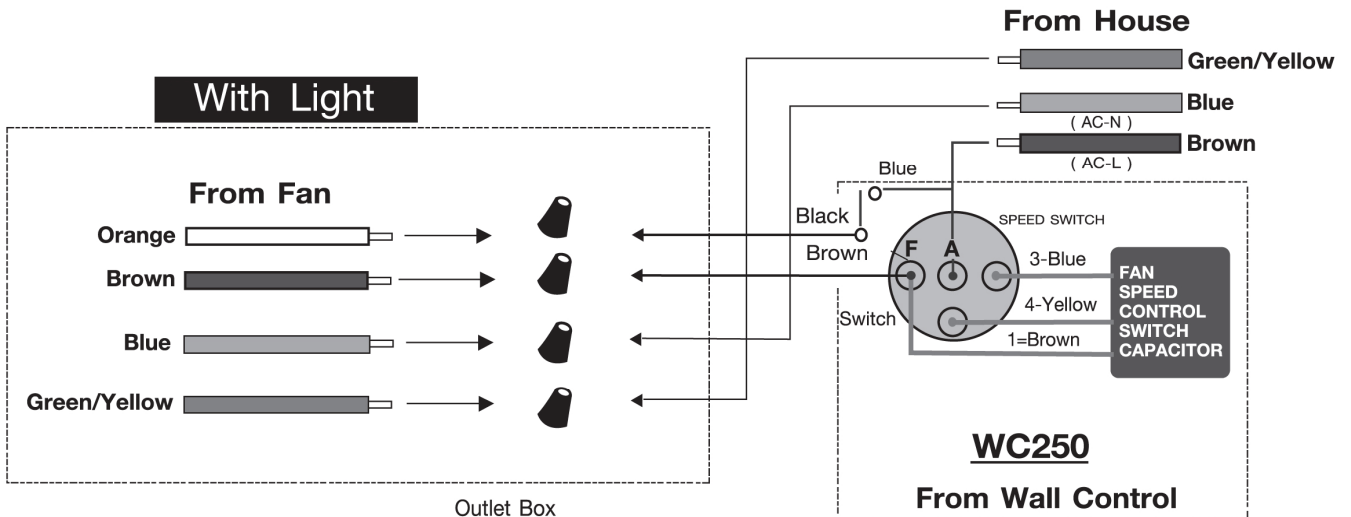

◇ For 3 Speed Wall Controller **WC350** Wire Connection (AC220~240V / 50Hz)

**CEILING FAN WALL CONTROL WIRING INSTRUCTIONS**

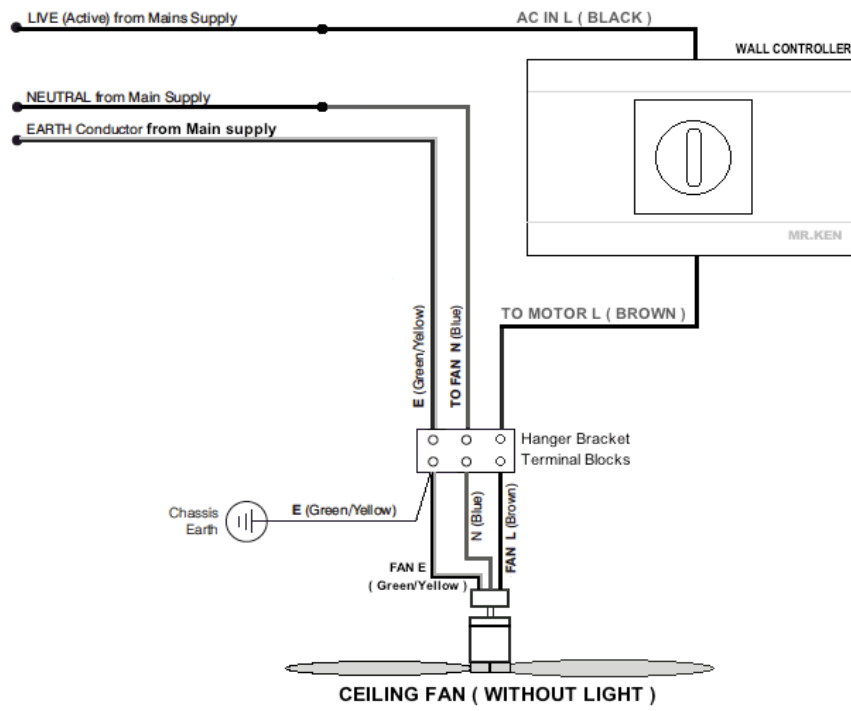

◇ For Remote Controller: (AC220~240V / 50Hz)

◎ AC Motor models :

**Make wire connections  
For use with remote controller**

**1. Prepare Remote Control**



This unit has 16 different code combinations.

**1. Setting the code on the TRANSMITTER**

- A. Remove battery cover.
- B. Slide code switches to your choice of ON or OFF position. Use a small screwdriver or ball point pen to slide each switch firmly up or down.
- C. Install 9V DC battery ( not included ).
- D. Install battery cover on transmitter.

2. Slide code switches on the receiver to be the SAME POSITIONS as set on your transmitter.

**2. Make wire connection - ( for 220~240VAC/50Hz )**

Follow diagram below and make sure that all exposed wires are secured inside wire nuts or terminal block.  
Note : Wires from house may vary in color and may not include ground wire ( green ). After wiring is completed, gently push wires into junction box with wire nuts pointing upward.

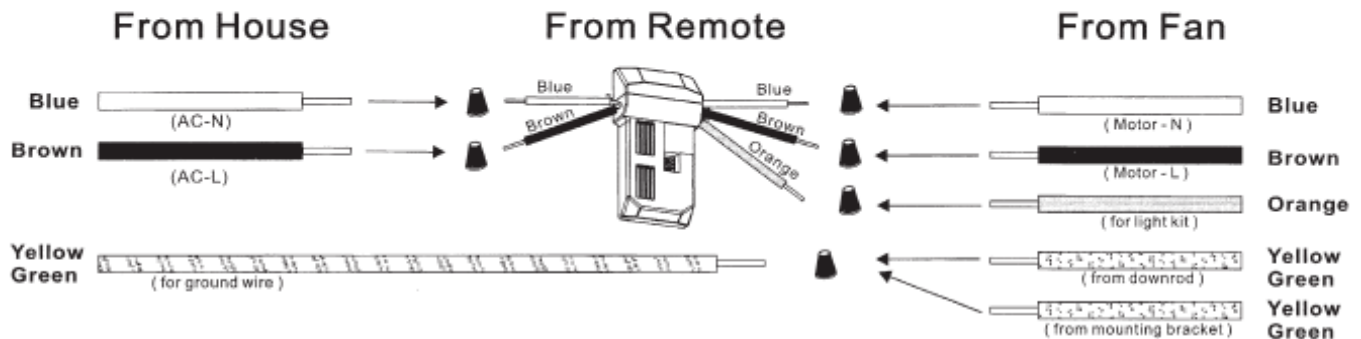

**Secure with twist - lock wire nuts (Included).**